



Triathlon IITM AC Power Source

T2FC-31-1K

3 Phase Input - 1 Phase Output

1 KVA

USER'S MANUAL

GEORATOR Corporation
9617 Center Street
Manassas, Virginia 20110
USA

800-523-9938, 703-368-2101, fax 703-368-1078

WWW.Georator.com

TABLE OF CONTENTS

A.	IMPORTANT SAFETY INSTRUCTION	3
B.	INTRODUCTION	5
C.	CIRCUIT THEORY	6
D.	FRONT PANEL LAYOUT	7
E.	OUTER CONSTRUCTION	
	■ SINGLE PHASE.....	9
	■ THREE PHASE.....	10
F.	INTERNAL CONSTRUCTION	11
G.	INSTALLATION	
	■ SAFETY PRECAUTIONS.....	12
	■ INSTALLERS.....	12
	■ INSTALLATION CONSIDERATION.....	13
	■ UNLOADING AND EXTERNAL INSPECTION.....	15
	■ INTERNAL INSPECTION.....	115
	■ WIRE SIZE GUIDELINES.....	17
	■ TABLE 1: POWER LINE REFERENCE DATA.....	18
	■ POWER WIRING.....	23
	■ POWER SOURCE POLARITY IDENTIFICATION.....	24
H.	OPERATION PROCEDURE	
	■ PRELIMINARY INSPECTION.....	25
	■ INITIAL SYSTEM OPERATION.....	25
I.	MAINTENANCE	
	■ PRECAUTIONS.....	26
	■ PERIODIC MAINTENANCE.....	26
J.	TROUBLESHOOTING	27
K.	TECHNICAL SPECIFICATION	28

A. IMPORTANT SAFETY INSTRUCTIONS

Save These Instructions.

Thank you for selecting this AC Power Source (Variable Voltage / Frequency Converter). This manual explains how to correctly install, operate, maintain, service, and get the best performance from the unit. Please read this manual carefully before installing, then keep it near the unit for reference.

1. Use only attachment methods (electrical plugs, etc.) that are approved by the manufacturer or a recognized safety organization (UL, CE, CSA). Use of unapproved attachments may cause hazards to personnel and equipment.
2. Use only one AC power cord per AC receptacle. Do not overload any AC receptacle or extension cord. This may result in a shock or fire hazard.
3. Do not place this unit on an unstable cart, stand or table. Keep the unit on a flat, stable surface with adequate space around it for proper ventilation.
4. Slots, grilles and openings of the unit are provided for ventilation, to protect it from overheating, and to ensure reliable operation. These openings must not be covered, and the rear panel of the unit must be at least 5 inches (10 to 15 cm) from any wall.
5. This unit should be operated only from power sources for which it is rated. Do not attempt to operate the unit beyond its ratings. In the event of an electrical storm, unplug the unit to prevent damage.
6. The power cord is used as a main disconnect device. Disconnect the power cord before servicing.
7. Do not allow anything to rest on the power cord since inadvertent damage or hazards may occur. Avoid locating the power cord in high traffic areas.

8. Do not place the unit near a heat register, and avoid placing the unit in direct sunlight. Do not place the unit near water or excessive moisture.
9. Service to this unit should be done by factory-trained personnel only. Opening or removing covers may expose dangerous voltage points or other hazards.
10. Adjust only those controls that are listed by the Adjustment Section. If the unit does not operate normally by following the operating instructions, contact the factory for assistance.

B. INTRODUCTION

GENERAL PRODUCT FEATURES:

- This unit is suitable for use with Resistive, Capacitive, Inductive and Non-linear loads.
- 0 to 150VAC (Low) and 0 to 300VAC (High) Output Voltage Selector.
- 40 to 500 Hz Output Frequency Programmable Key Lock Setting.
- Easy-to-read: 4 LED Digital Meters display Output Frequency, Voltage, Amperage & Wattage.
- Fully Galvanic Isolated. No Harmonic Distortion (EMI, EMC).
- Pure and Stable Sine wave Output.
- Sustained 300% Overload Capability.
- IGBT Module generates High Efficiency, Low Noise and Max. Reliability.
- PWM technology enhances Compact Size, Light Weight.
- Capable of simulating the AC Voltage and Frequency used in all countries.
- ***Units are equipped with Protection Circuits / Buzzer Alarm for Over Voltage, Over Current, Over Temperature and Output Short Protection.***

C. CIRCUIT THEORY



IGBT/PWM PRINCIPLE:

This AC Power Source is a device that takes electrical input power at one frequency and voltage and provides variable output voltage and frequency for testing loads over their full voltage and frequency. Solid State units convert incoming AC Power into DC power, and then convert the DC into the required Output Power. Its design is based on advanced DSP and IGBT / High Frequency PWM (Pulse Width Modulation) technology. The unit employs advanced DSP circuitry to offer precise and high speed measurement of true RMS voltage, frequency, current, power and power factor. The unit uses an IGBT module to reduce circuit complexity, and PWM technology to deliver high power output in a light weight and compact casing. Internally, a high quality Pure Sine wave is generated and passed through a low distortion linear amplifier to achieve the required high power output rating. Crystal Oscillation is used to enhance frequency stability.

T2FC series AC Power Sources have the ability to simulate the AC voltage and frequency used in all countries. It is a good instrument for R&D, design, production testing, and QA verification. The T2FC series delivers maximum rated power for any output voltage up to 300Vac (L-N) / 520Vac (L-L for 3 phase units), and at any frequency between 40Hz to 500 Hz.

D. FRONT PANEL LAYOUT

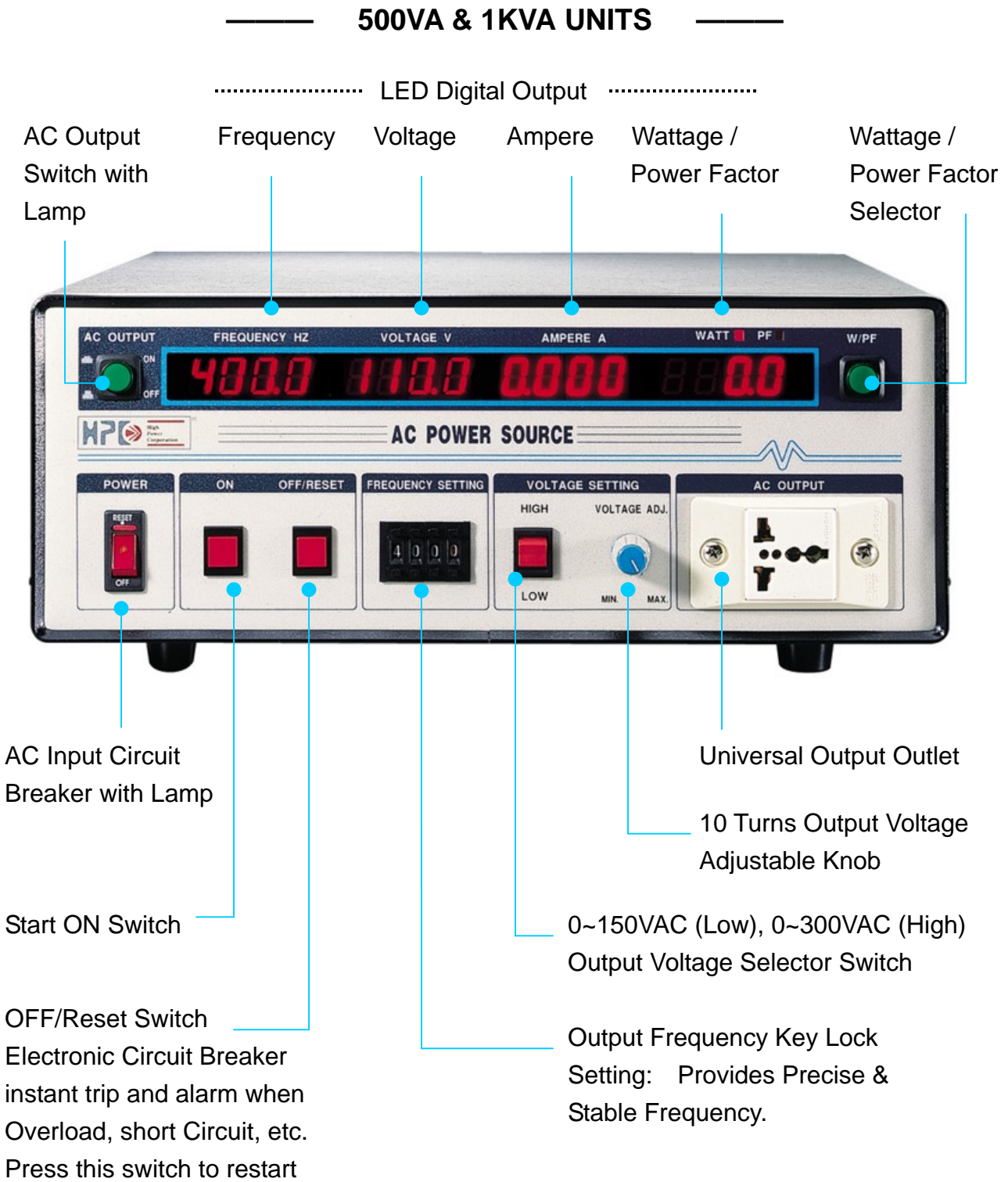

D. FRONT PANEL LAYOUT

SINGLE PHASE UNITS



THREE PHASE UNITS



E. OUTER CONSTRUCTION

(Number refer to locations on accompanying diagram)

SINGLE PHASE UNITS

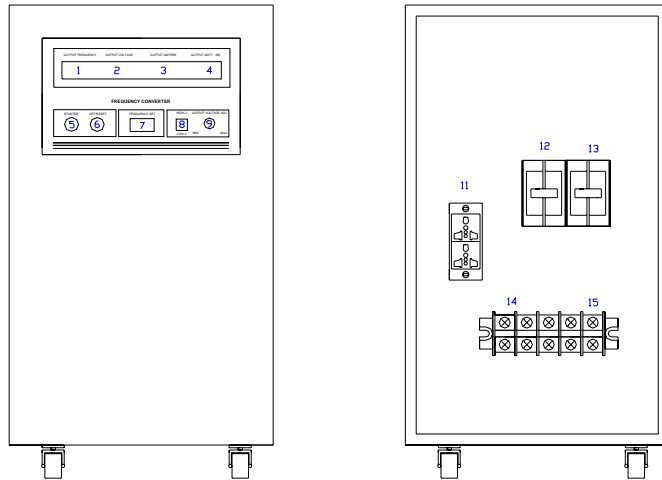

- 1. Frequency Meter (Hz):** 4 Digital LED display for output frequency.
- 2. Voltmeter (V):** 4 Digital LED display for output voltage.
- 3. Ammeter (A):** 4 Digital LED display for output current.
- 4. Wattmeter (W):** 4 Digital LED display for output power.
- 5. Start Switch:** Utility Power ON.
- 6. OFF/Reset Switch:** When the load is abnormal, a warning buzzer will sound, and power will be cut off. Press to reset the unit when the load returns to normal conditions.
- 7. Output Frequency Setting Counter:** Used to set the output frequency value.
- 8. Output High / Low Voltage Range Setting Switch.** Switch to select output voltage range of **0-300V (High: Orange LED light)** / **0-150V (Low: LED not lights on; Button raised)** .
- 9. Ten-turn Output Voltage Adjustment:** Adjusts output voltage value.
- 10. Phase Indicator:** Selects output phase to monitor (3phase models only).
- 11 Output Universal Outlet:** Max. 10A load.
- 12 Output Circuit Breaker**
- 13 Input Power Switch**
- 14 Input Terminal Block**
- 15 Output Terminal Block**

E. OUTER CONSTRUCTION

THREE PHASE UNITS

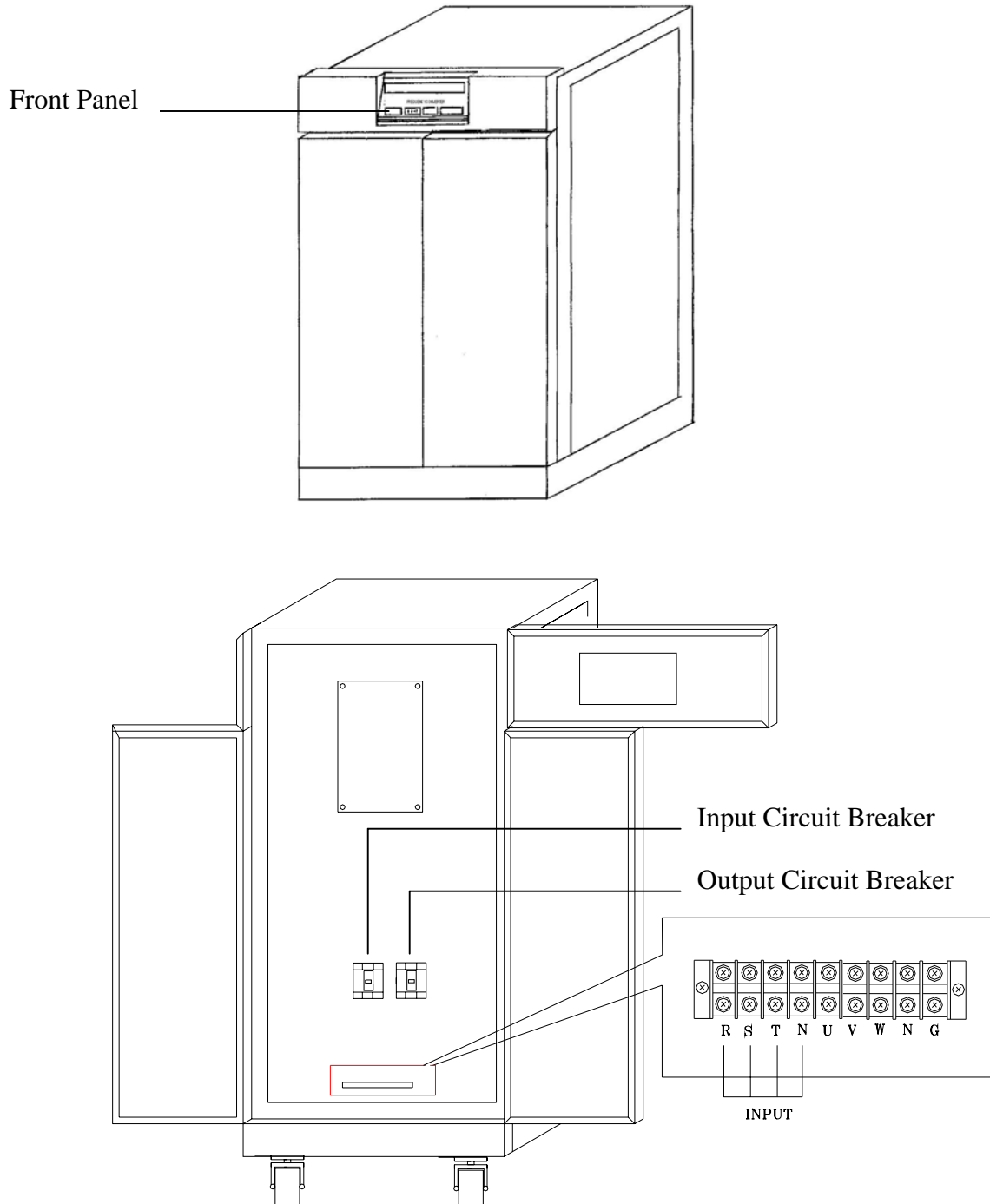

F. INTERNAL CONSTRUCTION

(Numbers refer to locations on accompanying diagram)

SINGLE PHASE UNITS



- | | |
|---------------------------|-------------------------|
| 1. Universal Outlet | 7. IGBT |
| 2. Input Power Switch | 8. Capacitor |
| 3. Output Circuit Breaker | 9. Magnetic Contactor |
| 4. Input Terminal Block | 10. Transformer |
| 5. Output Terminal Block | 11. Magnetic Contactor |
| 6. AC Fan | 12. Current Transformer |

G. INSTALLATION

SAFETY PRECAUTIONS

Read this manual thoroughly, paying special attention to the sections that apply to you, before working with the AC Power Source .



WARNING

Under typical operation, only normal safety precautions are necessary. The area around the AC Power Source should be kept free from puddles of water, excess moisture, or debris.

ONLY qualified service personnel should perform maintenance on the AC Power Source. When performing maintenance with any part of the equipment under power, service personnel and test equipment should be standing on rubber mats. The service personnel should wear insulating shoes for isolation from direct contact with the floor (earth ground).

Unless power is removed from the equipment, one person should never work alone. A second person should be standing by to assist and summon help in case an accident should occur.

INSTALLERS



ATTENTION INSTALLERS

Proper wire sizing (service ratings) and phase rotation are critical to the successful installation of this products.

Make sure you have installed properly sized external over-current protection.

G. INSTALLATION

Proper planning will speed AC Power Source unloading, location and connection. Make sure there is adequate clearance for the AC Power Source to open full swing. Check for a minimum of 5 inches (10 to 15 cm) from the rear panel of the unit to from any wall for exhaust air to flow without restriction. Make sure room has adequate ventilation and cooling. Install the AC Power Source in a clean and dry location.



WARNING

READ THIS MANUAL THOROUGHLY BEFORE ATTEMPTING TO WIRE OR OPERATE THE UNIT. IMPROPER INSTALLATION IS THE MOST SIGNIFICANT CAUSE OF AC POWER SOURCE START-UP PROBLEMS.

DO NOT INSTALL THE EQUIPMENT NEAR ANY GAS OR ELECTRIC HEATERS OR UNDER WATER LINES OR AIR CONDITIONING EQUIPMENT. INSTALL THE EQUIPMENT IN A RESTRICTED LOCATION TO PREVENT ACCESS BY UNAUTHORIZED PERSONNEL.

G. INSTALLATION

INSTALLATION CONSIDERATIONS

1. Utilize the shortest output distribution cable runs possible at the installation site, consistent with logical equipment arrangement and in compliance with NEC and local electrical codes. Allow space for future equipment additions.
2. Recommended ambient temperature for operation is 0° to 40° C (32° to 104° F). Relative humidity must be less than 90% non-condensing. In altitudes above 1,500meters, the AC Power Source rating will be reduced.
3. The foundation of the installation site must be capable of supporting the weight of cabinets and moving equipment.
4. Plan the route to ensure that the unit will pass through all elevators, corners, and doorways to prevent damage.

G. INSTALLATION

UNLOADING AND EXTERNAL INSPECTION

1. Inspect equipment and shipping container(s) for any signs of damage or mishandling. Do not attempt to install the system if damage is apparent. If any damage is noted, file a damage claim with the shipping agency within 24hours, and contact your dealer to inform them of the damage claim and the condition of the equipment.
2. Compare contents of the shipment with the bill of lading. Report any missing items to the carrier and to your dealer immediately.
3. Check the nameplate on the inside of cabinet front door to verify that the model number, KVA rating, and input voltage corresponds with the one specified. Record model and serial number in the inside of this unit. A record of this information is necessary should servicing become required.

INTERNAL INSPECTION

1. Verify that all items have been received.
2. If spare parts were ordered, verify arrival.
3. Check for shipping damage internally.
4. Check for any loose connections or unsecured components in the AC Power Source .
5. Check for installation of safety shields on the AC Power Source . There should not be any exposed terminals when the cabinet doors are opened.
6. Check for any unsafe features that may be a potential safety hazard.

G. INSTALLATION



WARNING

EACH AC POWER SOURCE WEIGHTS BETWEEN 45KGS (AROUND 100POUNDS) AND 1,230KGS (AROUND 2,700POUNDS), DEPENDING ON MODEL. EXERCISE EXTREME CARE WHEN HANDLING TO AVOID EQUIPMENT DAMAGE OR INJURY TO PERSONNEL. A FORKLIFT OR OTHER ADEQUATE MATERIAL HANDLING DEVICE SHOULD BE USED FOR UNLOADING, MOVING AND POSITIONING THE CABINETS.

INSTALLATION TIP

Install the leveling feet while the unit is on the forklift or other material handling equipment. Leveling feet cannot be installed with the unit sitting on its caster wheels.

1. Use a forklift or other material handling device to move the cabinets as close as possible to the final installation site.
2. Casters are provided on the unit to aid in final positioning.
3. As with all electrical equipment, installation and serviceability will be easier if access is provided on all sides of the equipment. Minimum access requirements are 3 feet front, 1 foot top.
4. Verify adequate clearance for cabinet doors to open.
5. Verify that openings are not covered and that the rear panel of the unit is at least 5 inches (10 to 15 cm) from any wall.
6. Verify that the AC Power Source is installed in a clean, cool and dry location.

G. INSTALLATION

WIRE SIZE GUIDELINES

Proper wire sizing must be based on numerous site-specific conditions. Refer to notes 1 through 6 below, the present edition of the NEC, and all applicable local codes for your particular site requirements.

1. Refer to the recommended wiring charts that show the Ampacities for your AC Power Source .
2. Input Ampacity must be based on 125% of input current at full rated load.
3. Be sure to refer to all requirements within Article 310 of NEC.
4. Minimum sized grounding conductors are to be per NEC 250-95.
5. Neutral conductors are to be sized per NEC 310-16, note 10.
6. The AC Power Source system must be installed in accordance with the present edition of the NEC and all local codes, including the codes of foreign countries where applicable.

G. INSTALLATION

TABLE 1: POWER LINE REFERENCE DATA

600PVC ISOLATED POWER LINE

PROTECTION BREAKER	POWER LINE (SAFETY CURRENT)	PROTECTION BREAKER	POWER LINE (SAFETY CURRENT)
19A	1.25 mm ²	162A	38.0 mm ²
27A	2.0 mm ²	190A	50.0 mm ²
37A	3.5 mm ²	217A	60.0 mm ²
49A	5.5 mm ²	257A	80.0 mm ²
61A	8.0 mm ²	298A	100.0 mm ²
88A	14.0 mm ²	344A	125.0 mm ²
115A	22.0 mm ²	395A	150.0 mm ²
139A	30.0 mm ²	469A	200.0 mm ²

AWG	Area (mm ²)	Dia (mils)	Dia (mm)
18	0.823	40.3	1.024
16	1.309	50.80	1.291
14	2.081	64.10	1.628
12	3.309	80.80	2.053
10	5.261	101.9	2.588
8	8.366	128.5	3.264
6	13.302	162.0	4.115
5	16.773	181.9	4.621
4	21.151	204.3	5.189
3	26.67	229.4	5.827
2	33.631	257.6	6.544
1	42.408	289.3	7.348
0	53.475	324.9	8.251
2/0	67.431	364.8	9.266
3/0	85.029	409.6	10.405
4/0	107.21	460.0	11.684
5/0	135.20	516.5	13.120
6/0	170.48	580.0	14.733

G. INSTALLATION

TABLE 1: POWER LINE REFERENCE DATA

MODEL	INPUT			OUTPUT	
	Volts	Amps	Power Line (AWG)	Volts	Amps (Max)
500W	220	15	18	110	L: 4.6
				220	H: 2.3
1101	220	15	18	110	L: 9.0
				220	H: 4.5

MODEL	Input 1Ø 2W 220V			Output 1Ø	
	MAX. I/P Current	Protection Breaker	Power Line	MAX. O/P Current	Power Line
1102	12.6A	30.0A	2.0mm ²	110V: 18.2A 220V: 9.1A	2.0mm ²
1103	19.0A	30.0A	3.5mm ²	110V: 27.2A 220V: 13.6A	5.5mm ²
1105	25.5A	50.0A	3.5mm ²	110V: 45.4A 220V: 22.7A	8.0mm ²
1108	50.5A	75.0A	14.0mm ²	110V: 72.8A 220V: 36.4A	22.0mm ²
1110	63.1A	75.0A	22.0mm ²	110V: 91.0A 220V: 45.5A	30.0mm ²
1115	94.7A	100.0A	30.0mm ²	110V: 136.4A 220V: 68.2A	38.0mm ²
1120	126.3A	150.0A	38.0mm ²	110V: 181.8A 220V: 90.9A	60.0mm ²
1130	189.4A	200.0A	80.0mm ²	110V: 272.8A 220V: 136.4A	125.0mm ²
1145	230.0A	250.0A	100.0mm ²	110V: 409.0A 220V: 204.5A	150.0mm ²

G. INSTALLATION

TABLE 1: POWER LINE REFERENCE DATA

Input 3Ø4W 127V/220V, 3Ø3W 220V				Output 1Ø	
MODEL	INPUT			OUTPUT	
T2FC-	MAX. I/P Current	Protection Breaker	Power Line	MAX. O/P Current	Power Line
3110	36.2A	50.0A	8.0mm ²	110V: 90.9A 220V: 45.5A	22.0mm ²
3115	54.3A	75.0A	14.0mm ²	110V: 136.4A 220V: 68.2A	38.0mm ²
3120	72.3A	100.0A	22.0mm ²	110V:181.8A 220V: 90.9A	60.0mm ²
3130	108.5A	150.0A	30.0mm ²	110V:272.8A 220V:136.4A	125.0mm ²

Input 3Ø4W 220V/380V, 3Ø3W 380V				Output 1Ø	
MODEL	INPUT			OUTPUT	
T2FC-	MAX. I/P Current	Protection Breaker	Power Line	MAX. O/P Current	Power Line
3110	9.5A	30.0A	5.5mm ²	110V: 90.9A 220V: 45.5A	22.0mm ²
3115	31.5A	50.0A	5.5mm ²	110V: 136.4A 220V: 68.2A	38.0mm ²
3120	42.0A	50.0A	8.0mm ²	110V:181.8A 220V: 90.9A	60.0mm ²
3130	63.0A	75.0A	22.0mm ²	110V:272.8A 220V:136.4A	125.0mm ²

G. INSTALLATION

TABLE 1: POWER LINE REFERENCE DATA

Input 3Ø4W 128V/220V, 3Ø3W 220V				Output 3Ø	
MODEL	INPUT			OUTPUT	
T2FC-	MAX. I/P Current	Protection Breaker	Power Line	MAX. O/P Current	Power Line
3303	10.9A	30.0A	2.0mm ²	110V: 9.0A 220V: 4.5A	2.0mm ²
3306	21.7A	30.0A	3.5mm ²	110V: 18.2A 220V: 9.1A	3.5mm ²
3310	36.1A	50.0A	5.5mm ²	110V: 27.6A 220V: 15.2A	5.5mm ²
3315	54.2A	75.0A	14.0mm ²	110V: 45.4A 220V: 22.7A	8.0mm ²
3320	72.2A	75.0A	22.0mm ²	110V: 60.6A 220V: 30.3A	14.0mm ²
3330	108.5A	150.0A	30.0mm ²	110V: 90.9A 220V: 45.5A	22.0mm ²
3345	162.6A	200.0A	60.0mm ²	110V: 136.4A 220V: 68.2A	38.0mm ²
3360	217.8A	300.0A	125.0mm ²	110V: 181.8A 220V: 90.9A	60.0mm ²
3375	271.3A	300.0A	125.0mm ²	110V: 227.2A 220V: 113.6A	100.0mm ²
33100	361.6A	400.0A	200.0mm ²	110V: 303.0A 220V: 151.5A	125.0mm ²
33120	434.0A	500.0A	250.0mm ²	110V: 363.6A 220V: 181.8A	200.0mm ²

G. INSTALLATION

TABLE 1: POWER LINE REFERENCE DATA

Input 3Ø4W 220V/380/480V, 3Ø3W 380/480V				Output 3Ø	
MODEL	INPUT			OUTPUT	
T2FC-	MAX. I/P Current	Protection Breaker	Power Line	MAX. O/P Current	Power Line
3306	12.6A	30.0A	2.0mm ²	110V: 18.2A 220V: 9.1A	3.5mm ²
3310	20.5A	30.0A	3.5mm ²	110V: 30.2A 220V: 15.1A	5.5mm ²
3315	31.5A	40.0A	5.5mm ²	110V: 45.5A 220V: 22.7A	8.0mm ²
3320	42.0A	50.0A	8.0mm ²	110V: 60.6A 220V: 30.3A	14.0mm ²
3330	63.0A	75.0A	22.0mm ²	110V: 91.0A 220V: 45.5A	30.0mm ²
3345	95.0A	125.0A	30.0mm ²	110V:136.0A 220V: 68.0A	38.0mm ²
3360	126.0A	150.0A	38.0mm ²	110V: 182.0A 220V: 91.0A	60.0mm ²
3375	158.0A	187.5A	50.0mm ²	110V:227.0A 220V: 113.5A	100.0mm ²
33100	210.5A	250.0A	80.0mm ²	110V:303.0A 220V:151.5A	150.0mm ²
33120	252.5A	300.0A	100.0mm ²	110V:363.6A 220V:181.8A	200.0mm ²

G. INSTALLATION

POWER WIRING



WARNING

ALL POWER SHOULD BE TURNED OFF BEFORE ANY CABLES OR WIRES ARE INSTALLED OR CONNECTED.

1. Verify that power wiring is run in individual, separate conduit or cable tray.
2. All Input wiring must be run in its own conduit.
3. All Output wiring must be run in its own conduit.

INSTALLATION TIP

For 3 phase units, make sure that wiring is installed with a clockwise phase rotation of all power wiring, Phase R leads Phase S leads Phase T.

4. Observe local, state and national electrical codes. Verify utility power and its over-current protection rating will accommodate the AC Power Source INPUT rating.
5. A safety ground wire must be run from building ground to ground point in the AC Power Source Cabinet. The grounding conductor shall comply with the following conditions of installation:
 - a. An insulated grounding conductor that is identical in size, insulation material, and thickness to the grounded and ungrounded branch-circuit supply conductors except that it is green with or without one or more yellow stripes is to be installed as part of the branch circuit that supplies the unit or system.
 - b. The grounding conductor described in Item a is to be grounded to earth at the service equipment or, if supplied by a separately derived system, at the supply transformer or motor-generator set.
 - c. The attachment-plug receptacles in the vicinity of the unit or system are all to be of a grounding type, and the grounding conductors serving these receptacles are to be connected to earth ground at the service equipment.
6. Observe clockwise phase rotation of all power rating, Phase R leads Phase S leads Phase T. A qualified electrician should check the phase rotation.

G. INSTALLATION

POWER SOURCE POLARITY IDENTIFICATION:

1. Line: The voltage of L-G or L-N should be nominal voltage.
2. Neutral: The voltage of L-N should be nominal voltage; N-G is around 0.5V~2V. (Neutral line has loading current conduit.)
3. Ground: Please find out the exact Grounding point.



WARNING

In case the voltage between Neutral and Ground is greater than 5V or computer specified tolerance, please check and re-install the AC Power Source by a qualified electrical contractor

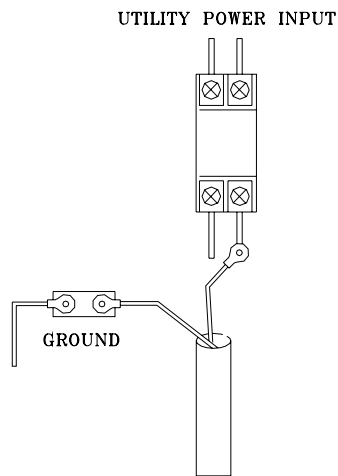

(1) INPUT: 1PHASE 2WIRE+G

(2) INPUT: 3PHASE 3WIRE+G



(3) INPUT: 3PHASE 3WIRE+N+G

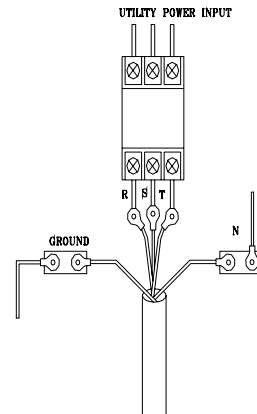

POWER SWITCH INTERIOR SCHEMATIC DIAGRAM

H. OPERATION PROCEDURE

PRELIMINARY INSPECTION

Inspect for damage that may have occurred during shipment. If any damage is noted, please contact your dealer without any hesitation. To have the unit runs smoothly, please confirm the following requirements prior to operation:

1. Assure all Circuit Breakers / Switches are at “**OFF**” status.
2. Verify all power connections are tight.
3. Verify all power wires and connections have proper spacing between exposed surfaces, phase-to-phase and phase-to-ground.
4. Measure with Digital Voltmeter all input and output voltage Phase to Phase; Phase to Line and Line to Line which voltages should be within the nominal range.

INITIAL SYSTEM OPERATION

When the above requirements have been approved, follow the start-up procedure listed below:

1. Put ON the Input Circuit Breaker. Use Digital Voltmeter to measure the input voltage is consistent with the requirements of the unit.
2. Set the AC Input Circuit Breaker at OFF position. Connect the load into the output.
3. Put ON AC Input Circuit Breaker.
4. Tune the Ten-turn Output Voltage Adjustment Knob counter- clockwise to ZERO.
5. Set 0-300V (High-V) / 0-150V (Low-V) Output Voltage Selector Switch to the required voltage position. Tune the Ten-turn Output Voltage Adjustment Knob to the desired settings.
6. Set Output Frequency Counter to the required output frequency.
NOTE: When setting 1xx.x Hz, be sure to press OFF/RESET button first; after that, power it on.
7. **T2FC-500VA to 1KVA:** Press Start ON Switch. All LED Meters will display present figures.
T2FC-2KVA to 150KVA: Press Power ON button at the front panel. All LED Meters will display present figures.
8. Put the Output Power Switch to the ON position.
9. When overload/short circuit, the unit will auto shutdown and buzzer alarm to protect the load. After troubleshoot the problems, press Power OFF/RESET button to restart.
10. Press OFF/RESET button to cut off output voltage.

I. MAINTENANCE

The unit does not require any routine maintenance. However, reasonable care of the unit will extend its life. The following preventive and periodic measures are recommended:

PRECAUTIONS

- Keep all liquids away from the unit. Accidental spillage of a liquid into the unit can cause severe damage.
- Do not block the air flow around the unit. Do not place tools, or other heavy equipment on top of the unit.
- Special care should be taken to protect the unit if it is used in an unfriendly environment such as a machine shop, a dusty or sandy area, etc.

PERIODIC MAINTENANCE

Cleaning the unit is the most important action the user can perform. The frequency of cleaning is dependent upon the environment.

- Turn the power OFF.
- Clean the case, covers and air flow openings with a soft cloth. Use any mild commercial cleaner as needed, insuring that no liquids enter the unit.
- Visually inspect all wires/terminals for damage, wear, etc. Repair or replace any defective parts.

NOTE: Do not perform any maintenance on the unit while it is in operation.

J. TROUBLESHOOTING

PROBLEMS		POSSIBLE CAUSE & ACTION TO TAKE
No Output Voltage	All (or some) meters can not light on.	<ol style="list-style-type: none"> 1. Power failure or blackout. 2. Input Power Switch is not at ON position. 3. Input Power Cables do not proper connected. 4. Meter is faulty; replace it.
	Output frequency displays normal, but Voltmeter and Ammeter displays “zero”; no buzzing sound is heard.	Adjust the Ten Turn Output Voltage Adjustment knob clockwise to the desired voltage value. (Be sure to power it OFF, unplug the unit, disconnect output switch for load protection.)
	While operating the unit, Output frequency displays normal, but Voltmeter and Ammeter display “zero”; buzzing sound is heard at the same time.	<ol style="list-style-type: none"> 1. Check and reduce load current. 2. Press “RESET” button to restart. 3. Return unit for service if the unit fails to start.
	Output Voltmeter displays normal, but no voltage output.	<ol style="list-style-type: none"> 1. Insure that Output switch is in the ON position. 2. Return unit for service if the unit fails to start.
Unable to adjust unit to High or Low Voltage Range	Output voltage cannot adjust above 150V or below 150V.	Switch Output Select Switch from low to high range, or high to low range.
Please contact the manufacturer for problems that are not listed.		



The Frequency Converter People Since 1950

GEORATOR Corporation

9617 Center Street
Manassas, VA 20110

800 523-9938

703 368-2101

Fax: 703 368-1078

E-Mail: sales@georator.com

Triathlon II AC Power Source Specification (Fully Adjustable Frequency Converter)			
3 Phase Input to 1 Phase Output Model - 1 KVA			
Model		T2FC-31-1K	
Output KVA		1	
Input	Voltage (select one individual voltage)	3 Phase Wye 190/200/208/220/230/240V +/- 10% 3 Phase Wye 380/400/415/440/460/480V +/- 10%	
	Frequency	47-63 Hz	
	Power Factor	0.6 - 0.7	
Output	Voltage	110V Setting: 0-150V (Low Range) 220V Setting: 0-300V (High Range) (optional 0-600V)	
	Voltage Regulation	<= 1%	
	Current Limit	L-N at 120 V	L: 8.4A
		L-N at 240 V	H: 4.2A
	Frequency	47-63 Hz (Optional 40 to 500 Hz)	
	Power Factor	0.7	
	Distortion (THD)	<= 2%	
	Crest Factor	3:1	
	Overload Capacity	120% > 2 sec., 120-150% 2 sec., 200% Instant Trip	
Efficiency	> 80%		
Indicators	LED	Freq. (0.1 Hz), Volt (0.1V), Amp (0.1A), Power (0.1W)	
Protection	Output Short Circuit	Electronic circuit breaker	
	Overload	Electronic circuit breaker	
	Over Temperature	Electronic circuit breaker instant cut off	
	EMI/EMC	Output Filter	
Environment	Operating Temperature	0° – 40° C	
	Humidity	0 - 90% Non-condensing	
	Audible Noise	< 45 dB at 1 meter	
Dimensions	W x H x D (mm)	430*190*450	
	W x H x D (in)	16.9*7.5*17.7	
Weight *	Kilograms	36.0	
	Pounds	79.4	

* Weights may vary based on input/output frequency/voltage/phase