



**MAINTENANCE AND OPERATING INSTRUCTIONS
MODEL 30-090 MOTOR-GENERATOR
"NOBRUSH" PERMANENT MAGNET FREQUENCY
CONVERTER
HORIZONTAL UNIT SHELL TYPE**

GEORATOR Corporation
9617 Center Street
Manassas, Virginia 20110
USA
800-523-9938, 703-368-2101, fax 703-368-1078
WWW.Georator.com



SPECIFICATION
GEORATOR CORPORATION
MANASSAS, VIRGINIA 20110

Model No. 30-090
Type 51-A Frequency Converter

1.0 INPUT:

- 1.1 Motor: Baldor Rotor & Stator, 1.5 H.P., 1 Phase, 50 Hz, 115/230V, 2900 RPM (Nom.), Capacitor Start, Induction Run, Georator P/N 18-283
- 1.2 Input Current: 20/10 Amperes
- 1.3 Insulation: Class B
- 1.4 Maximum Ambient Temperature: 50 Degree C
- 1.5 Duty: Continuous

2.0 OUTPUT:

- 2.1 Rating: 1.0 KVA, 100% P.F., 1 Phase, 400 Hz (Nom.), 115V (Nom.)
- 2.2 Output Voltage, No Load: 124 +-1V
- 2.3 Output Frequency Tolerance: 400 Hz @ N.L. To 386 Hz Min. At F.L.
- 2.4 Output Current: 8.7 Amperes
- 2.5 Insulation: Class B
- 2.6 Maximum Ambient Temperature: 50 Degree C
- 2.7 Dielectric Strength, Winding To Frame: 1500V For 1 Minute

3.0 VIBRATION: Within 0.001

4.0 BEARINGS: Shielded Life Time Lubricated

5.0 FINISH:

- 5.1 Primer: Iridite
- 5.2 Paint: Silver-Blue Enamel
- 5.3 Fasteners: Zinc-Plated

6.0 APPROX. WEIGHT:

- 6.1 Net: 116 Lbs.
- 6.2 Shipping: 146 Lbs.

Revision Letter	Date	Revision Description
ENGINEER	M.T.E.	
APPROVED BY		April 20, 1998

GEORATOR CORPORATION
Manassas, Virginia

MAINTENANCE AND OPERATING INSTRUCTIONS
MODEL 30-090 MOTOR-GENERATOR
"NOBRUSH" PERMANENT MAGNET FREQUENCY CONVERTER
HORIZONTAL UNIT SHELL TYPE

NOTE

These instructions are general in nature. Some particular models may vary in size and precise locations for components. However, we believe that the user will be able to make those adjustment mentally. If you are at all concerned, please feel free to contact Georator Corporation with any questions you may have.

GENERAL

The unit shell type of "NoBrush" frequency converter utilizes a metal housing enclosing both motor and generator components. In most models, this housing or shell is an aluminum casting. In a few militarized models, it is a wrought steel shell. The motor and generator stators are mounted within this shell. The motor and generator rotors are mounted upon a unit shaft, which rotates in ball bearings in the two end bells. The shaft does not project from the end bells.

The internal construction of both the motor and generator resemble very closely that of a three phase, squirrel cage, induction motor. The maintenance attention required will be the as would be required for a three phase motor, operating under similar conditions.

Normally, it should not be necessary to dismantle the unit. Generally, attention will be required only if the unit has accidentally been splashed with or immersed in water or has been exposed for long periods to very dusty atmospheres, especially where fibrous dust exists. In such cases it will be desirable to disassemble the unit, clean the windings and re-treat with varnish if necessary.

This contingency is not a usual one. A safe guide to the need for treatment would be that noted above, namely, whatever treatment would have been appropriate for a three phase induction motor, subjected to the same conditions.

The other condition for which disassembly may be required will be replacement of a defective bearing. The procedure for disassembly of the unit and replacement of the bearings is given on page 2.

The generator unit will not be adversely affected by a dead short circuit applied across its terminals. A prolonged short circuit may overheat the unit and may also result in damage to the associated wiring and equipment. Normal overload protection should therefore be provided.

The "NoBrush" generator portion of the converter will deliver a very stable voltage at constant load, without the use of a regulator. In most cases the voltage will remain within acceptable limits throughout the full range of rated load. This makes possible total elimination of a regulator.

For those applications where very close voltage control is required, despite large variations in load, regulators are available as auxiliaries.

LUBRICATION

In most models, sealed, lubricated-for-life bearings are utilized. These will not normally need lubrication nor other attention of any sort.

In some models, provision for re-lubrication has been made. These models can be distinguished by a removable circular cover at the center of each end bell, held by small screws. To re-lubricate these models, the screws and end cover are removed, clean grease applied with a spatula, the cover replaced and any excess grease wiped off.

INPUT AND OUTPUT CONNECTIONS

The large rectangular terminal box at one side of the unit has the motor and generator terminals. The motor terminals can be distinguished by the fact that the motor connection diagram is directly above them. This diagram is usually on an etched plate, giving the scheme of re-connection for different input voltages.

Units which operate from single phase input are provided with a starting relay and starting capacitor. These are similar to the usual relay and capacitor arrangements used for capacitor-start motors.

Replacements for the relay or capacitor can generally be obtained from motor parts supply houses. Care should be taken that the replacement capacitor is of the same voltage rating and approximately the same capacitance as that it replaces. If a replacement relay is utilized, care should be taken to see that it does not have a greater overall height than the relay it replaces. Capacitor replacements are required only rarely and relay replacements extremely rarely.

Wear or deterioration of the relay contacts will be dependent upon the number of times the unit is started. If started infrequently, on the average of once a day or so, inspection of the contacts

about once a year will suffice. If started several times a day, inspection should be about every six months. Maintenance will consist of dressing the contacts if they appear to be badly burned or pitted.

PROCEDURE FOR DISASSEMBLY OF THE UNIT AND REPLACEMENT OF BEARINGS

1. Remove the through bolts, Item 8, nuts, Item 9, and also the end bell plugs, Item 7. Remove both end bells, Items 4 and 5.
2. Set converter upright on motor end on a wooden block, about three inches high and not larger than the inside diameter of the motor stator.

NOTE: The motor stator has a smaller inside diameter than the generator stator and can be distinguished in this way.

3. Press housing (frame), Item 1, downward. Magnetic forces will tend to hold the rotor in place so that considerable pressure may be required, especially on the higher rated models of 2 or 3 KVA output.
4. Lift shaft assembly, Item 2, from housing. Store generator rotor away from magnetic materials to avoid partial demagnetization or clinging of magnetic particles. It is recommended that the rotor be wrapped with paper temporarily to keep it free of magnetic particles.
5. Bearings may be removed with a bearing or gear puller.
6. To replace bearings, Item 3, press only on the inside race-- do not tap.

NOTE: Bearings require only a light push fit. Never remove a bearing that is not to be replaced with a new one. Removal and replacement may seriously shorten its life.

TO REASSEMBLE

1. Put end bell, Item 5, on the motor end of the housing, Item 1.
2. Set upright on end bell.
3. Lower shaft assembly, Item 2, carefully into housing and push shaft gently into bottom end bell.
4. Put generator end bell, Item 4, on and push into housing.

5. Replace through bolts, Item 8 and nuts, Item 8.
6. Replace plugs, Item 7.

ITEM	DESCRIPTION	QTY.
1	FRAME	1
2	STATOR ASSY., GENERATOR	1
3	STATOR ASSY., MOTOR	1
4	RETAINING WASHER	16
5	SCREW	16
6	SHAFT ASSY.(SHAFT, GEN.ROTOR, MOTOR ROTOR, FAN	1
7	BALL BEARING	2
8	END BELL	2
9	SPRING WASHER	1
10	PLUG, END BELL	2
11	THRU BOLT	4
12	NUT	8
13	TERMINAL BOX	1
14	SCREW	4
15	FLATWASHER	4
16	RELAY	1
17	BRACKET	1
18	CAPACITOR	1
19	CAPACITOR	1
20	SCREW	4
21	LOCKWASHER (NOT SHOWN)	2
22	BRACKET	1
23	COVER	1
24	SCREW	4
25	LOCKWASHER	4
26	PLUG	1
27	NAME PLATE	1
28	SCREW	4
29	LOCKWASHER	8
30	SCREW	4
31	COVER	1
32	BOLT	4
33	PLUG	1

× ITEM 16, 17, 18, 19, 20, 21, 22, 30,31, WITH SINGLE PHASE ONLY

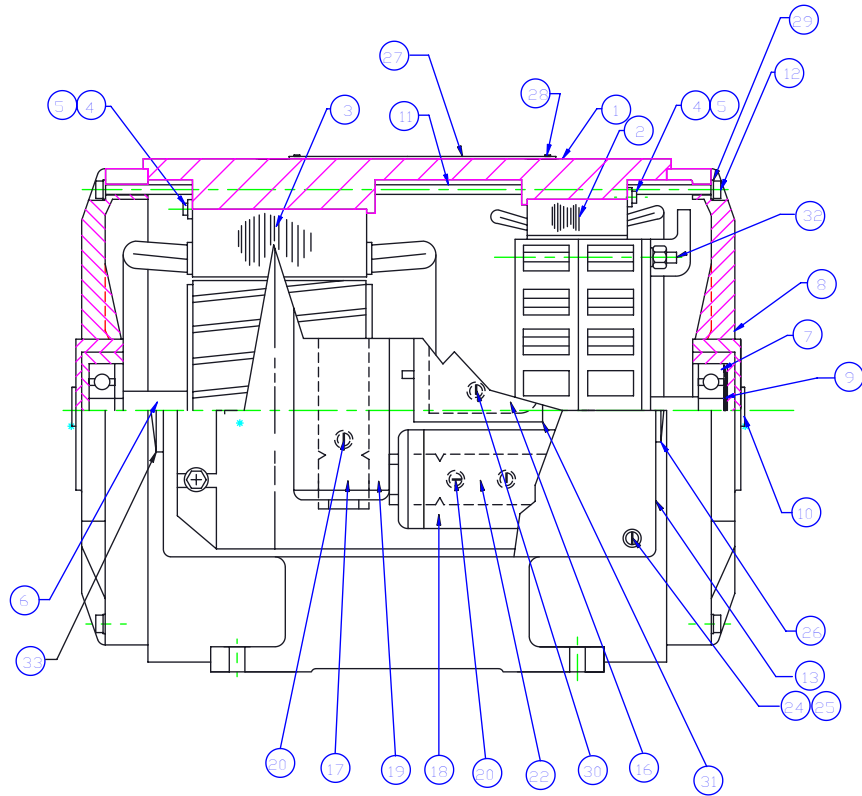

WHEN ORDERING PARTS ALWAYS GIVE MODEL NO. AND SERIAL NO.

REV	DESCRIPTION	DATE	BY	ORIGINAL 11/27/71 1 REV 4/5/72 2 REV 4/5/72 3 REV 4/5/72 4 REV 4/5/72	SERIAL NO. 1000 SERIAL NO. 1000 SERIAL NO. 1000 SERIAL NO. 1000	 GEORATOR Corporation 9617 Center Street, Moncks, VA 20110-2521, U.S.A. Telephone: (703) 368-2201 FAX: (703) 368-1078
				PLOT TO FIT THIS DRAWING AND ANY PARTS THEREOF ARE THE PROPERTY OF GEORATOR CORPORATION AND ARE SUBJECT TO RETURN OR RECALL BY THE COMPANY. THE INFORMATION HEREIN IS CONFIDENTIAL AND NOT TO BE DISCLOSED TO ANY OTHER PARTY WITHOUT THE WRITTEN PERMISSION OF GEORATOR CORPORATION.	DATE 3/19/98 REV 002-140.DWG SHEET 1 OF 1	ASSEMBLY DRAWING SERIES 30 U.S. CONVERTERS SEE PARTS LIST
				A 22-140 A		

REV	DESCRIPTION	APP'VD	DATE
A	3/4 COND. WAS 1/2, E.C. #69		8/8/67
B	ADDED: 3.96 DIM. 2-3-71		2/3/71
C	16.5 WAS 15.8		5/21/85
D	REDRAWN IN AUTOCAD	B.S.O.	04/04/00

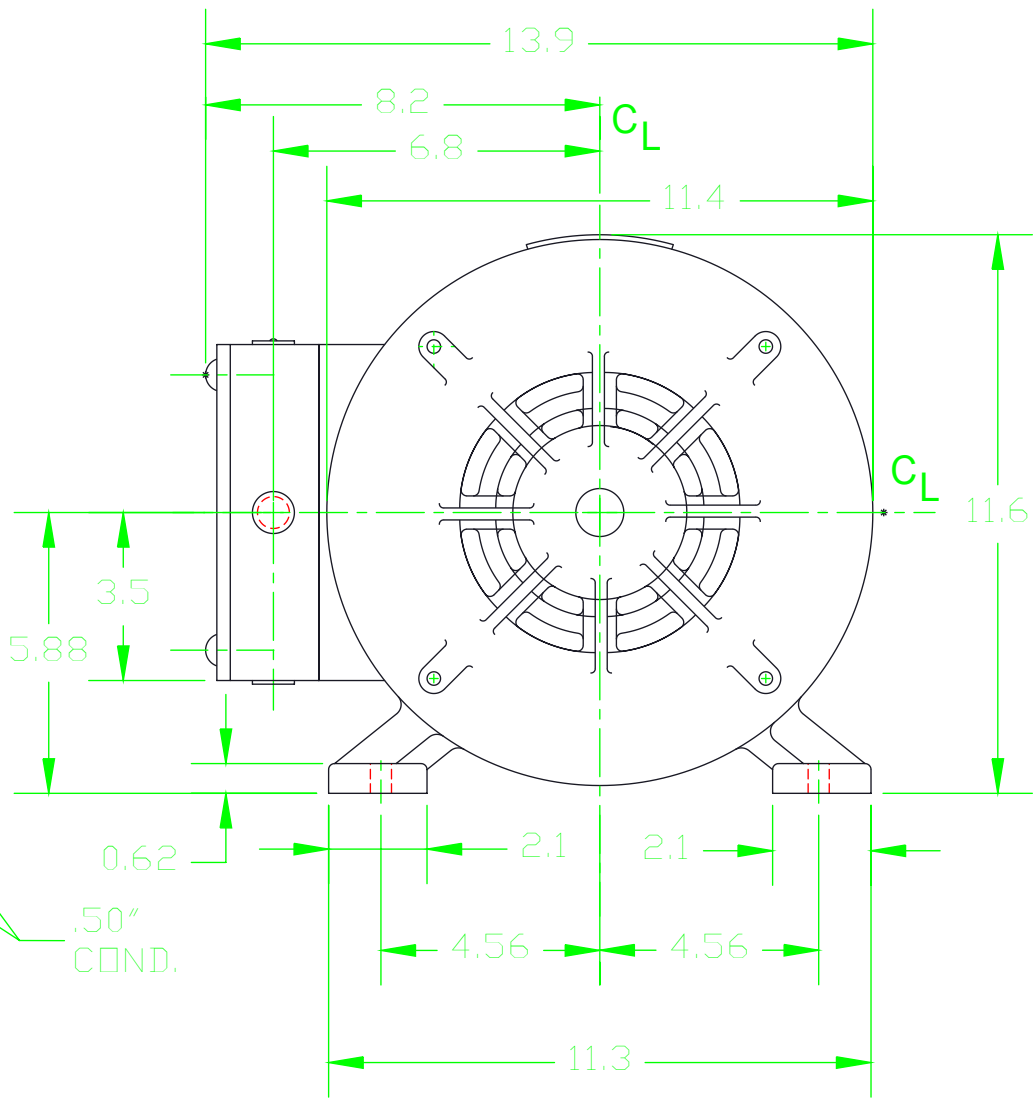
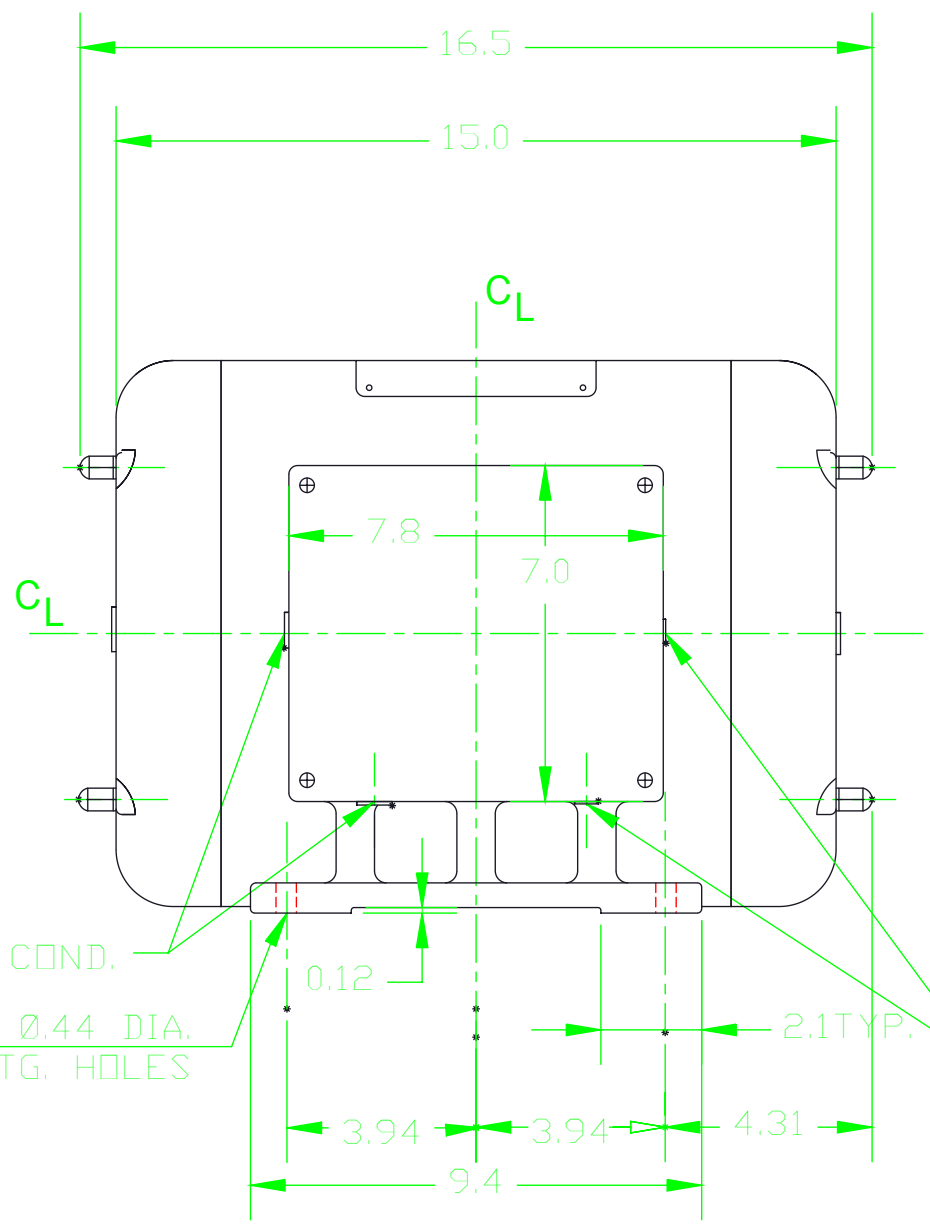

.75" COND.
(4)X Ø.44 DIA.
MTG. HOLES

.50" COND.

UNSPECIFIED TOLERANCES
FRACTIONAL N/A
DECIMAL
.X ±0.1 ANGULAR ±N/A
.XX ±0.03
.XXX ±0.010

PLT @ .FIT

This drawing and any part thereof is the property of GEORATOR CORPORATION, and is subject to return on request by this company. The information shown is confidential and the recipient by accepting this drawing agrees not to use any information contained thereon in any manner which will be detrimental to GEORATOR CORPORATION.

UNLESS OTHERWISE SPECIFIED DIMENSIONS ARE IN INCHES.
NEXT ASSY
XXXXXXXXXX

DO NOT SCALE DRAWING NAME
DATE 09/16/65
DRAWN F.L.
FILE 23-026.DWG
APP'D.
SCALE NONE



GEORATOR Corporation
9617 Center Street Manassas, VA 20110-5521, US
Telephone (703)-368-2101 FAX (703) 368-1078

OUTLINE DRAWING
SERIES 30 UNIT SHELL CONVERTER

MATERIAL

FINISH SILVER-BLUE ENAMEL
SHEET 1 OF 1

DWG. NO. A 23-026

REV.

INPUT

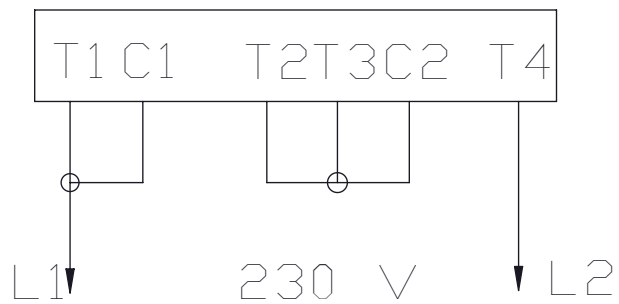
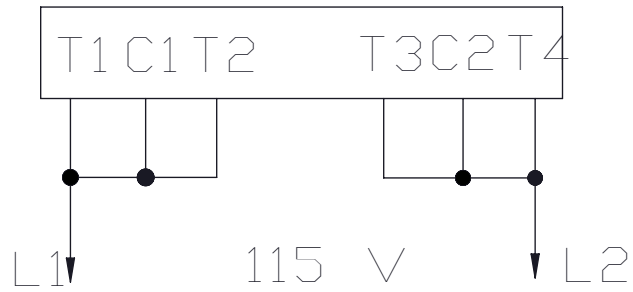

OUTPUT

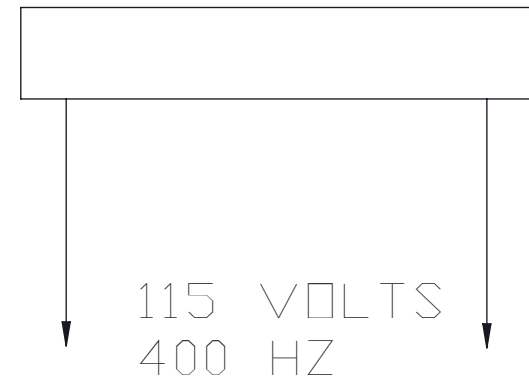

TO REVERSE ROTATION INTERCHANGE C1 & C2

				UNSPECIFIED TOLERANCES FRACTIONAL ±1/32 DECIMAL 1 PLACE ±0.1 2 PLACE ±0.03 3 PLACE ±0.01 ANGULAR ±1/2	UNLESS OTHERWISE SPECIFIED DIMENSIONS ARE IN INCHES.	 GEORATOR Corporation 9617 Center Street Manassas, VA 20110-5521, USA Telephone (703)-368-2101 FAX (703) 368-1078
				PLOT @: TO FIT	DO NOT SCALE DRAWING	
					DATE 9-5-62	WIRING DIAGRAM
					DRAWN F.L.	INPUT: 1 PHASE OUTPUT: 1 PHASE
					FILE 25-043.DWG	MATERIAL
	REDRAWN IN CAD	4-20-02	MH		APP'D:	FINISH
REV	DESCRIPTION	DATE	BY		SCALE NONE	SHEET 1 OF 1
						BWG. NO. A 25-043
						REV. A